

January 30, 1998

TEL:805-498-2111 FAX:805-498-3804 WEB:http://www.semtech.com

## DESCRIPTION

The SC1660 is a monolithic CMOS switched capacitor voltage converter. Designed to be an improved direct replacement for the popular 7660, the SC1660 provides performance superior to previous designs by combining low quiescent current with high efficiency, and by eliminating diode drop voltage losses. The only required external components are two low cost electrolytic capacitors.

## FEATURES

- Improved direct replacement for 7660
- Easy to use
- 1.5V to 9V operation
- No external diode required
- Simple conversion of +5V to  $\pm 5V$
- Low quiescent current
- High power efficiency
- Boost pin for higher switching frequency

## TEST CIRCUIT

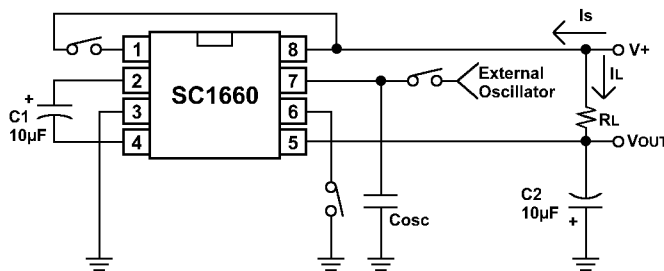

## APPLICATIONS

- RS-232 power supplies
- Handheld instruments
- Data acquisition systems
- Supply splitter,  $V_{OUT} = \pm V_S/2$
- Operational amplifier supplies

## ORDERING INFORMATION

DEVICE <sup>(1)</sup>	PACKAGE
SC1660CN	8-Pin DIP
SC1660CS	SO-8

Note:

(1) Add suffix 'TR' for tape and reel.

## PIN CONFIGURATION

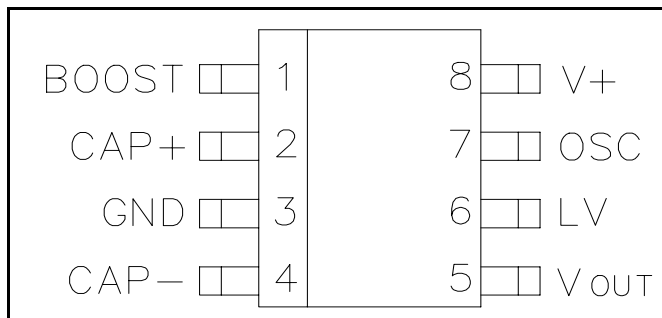

## ABSOLUTE MAXIMUM RATINGS

Parameter	Symbol	Maximum	Units
Supply Voltage	$V^+$	9.0	V
Operating Temperature Range	$T_A$	-40 to 85	°C
Storage Temperature Range	$T_{STG}$	-65 to 125	°C

January 30, 1998

**ELECTRICAL CHARACTERISTICS**

 Unless otherwise specified,  $T_A = 25^\circ\text{C}$ ,  $V^+ = 5\text{V}$ , OSC = free running

Parameter	Symbol	Conditions	Min	Typ	Max	Units
Input Voltage	$V^+$	$R_L = \infty$	1.5		9	V
Supply Current	$I_S$	$R_L = \infty$		35	70	$\mu\text{A}$
Output Resistance	$R_{\text{OUT}}$	$I_L = 20\text{mA}$ , $f_{\text{OSC}} = 10\text{kHz}$		45	90	$\Omega$
Oscillator Frequency Pin 1= $V^+$	$f_{\text{OSC}}$	$R_L = \infty$		10 50		kHz
Efficiency	$\eta$	$R_L = 5\text{K}$ , $f_{\text{OSC}} = 10\text{kHz}$	96	98		%
Voltage Conversion Efficiency	$\eta_{V_{\text{OUT}}}$	$R_L = \infty$	98	99.9		%

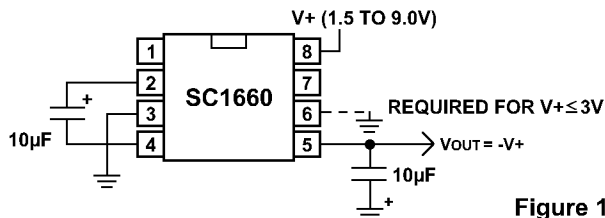
**TYPICAL APPLICATIONS**

**Figure 1**

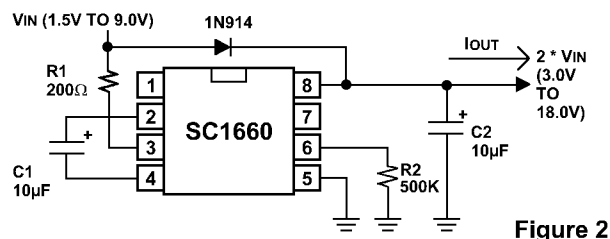
- Negative Voltage Converter**  
 Figure 1 shows a typical connection which will provide a negative supply from an available positive supply without the need for any external diodes. The LV pin should be connected to ground for  $V^+ \leq 3\text{V}$ ; for  $V^+ > 3\text{V}$  it may be left floating.

**Figure 2**

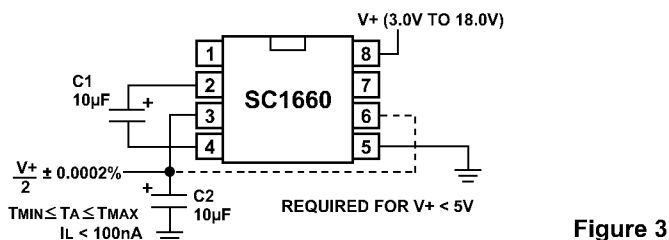
- Voltage Doubling**  
 Figure 2 shows a method of voltage doubling. Doubling is achieved by simply rearranging the connection of the two external capacitors. An external 500k $\Omega$  resistor is required to ensure the oscillator will start.

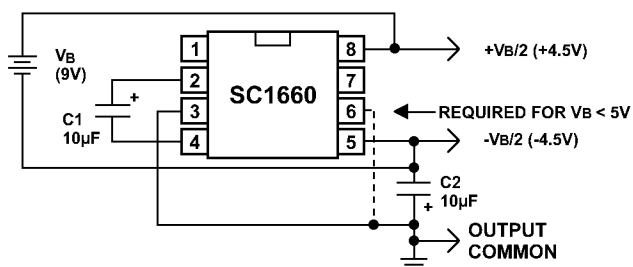
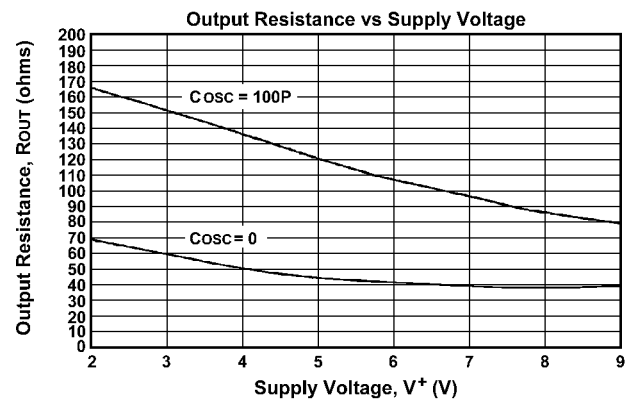
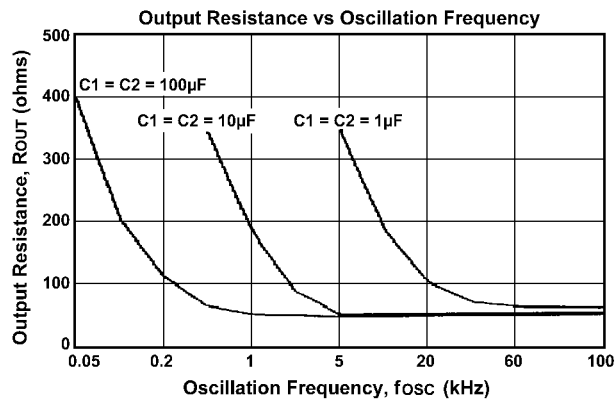
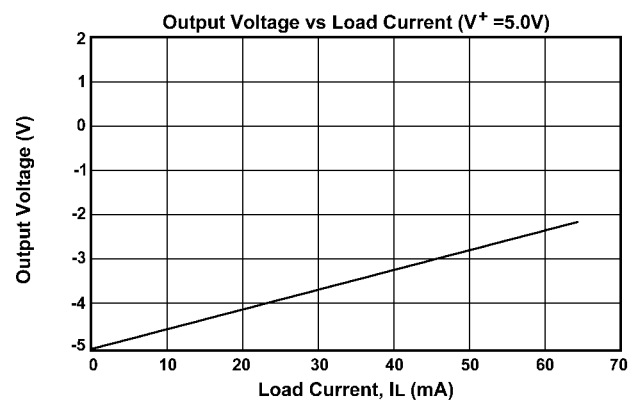
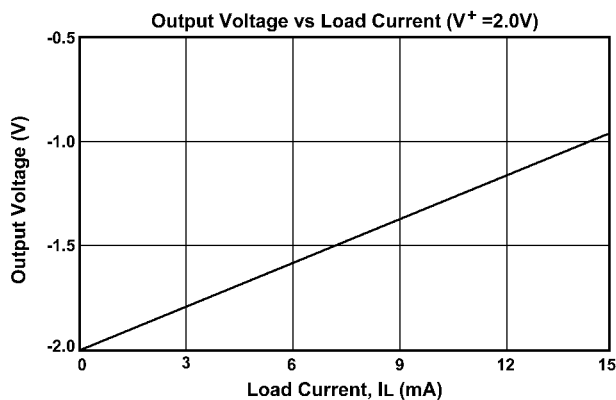
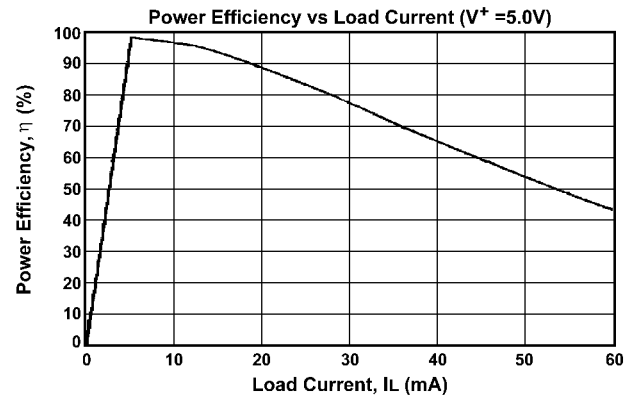
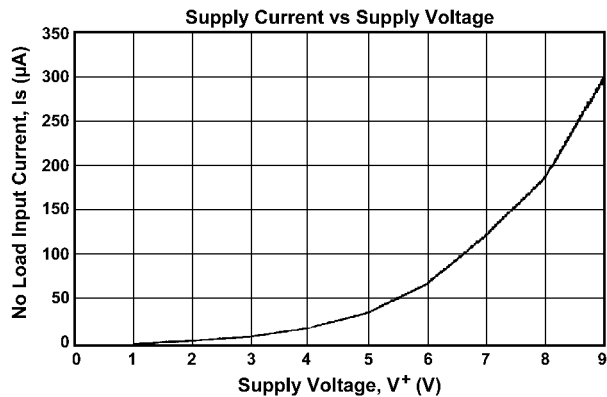

**Figure 3**

- Ultra Precision Voltage Divider**  
 An ultra precision voltage divider is shown in Figure 3. To achieve the 0.0002% accuracy indicated, the load current should be kept below 100nA. However, with a slight loss in accuracy, the load current can be increased.

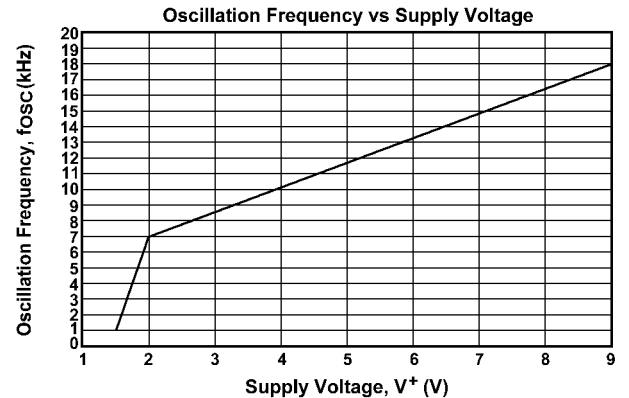
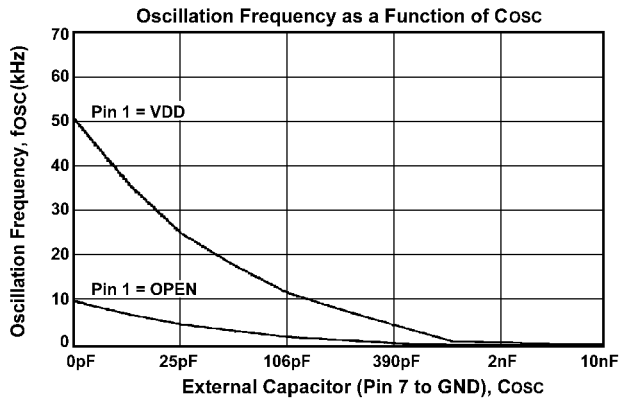
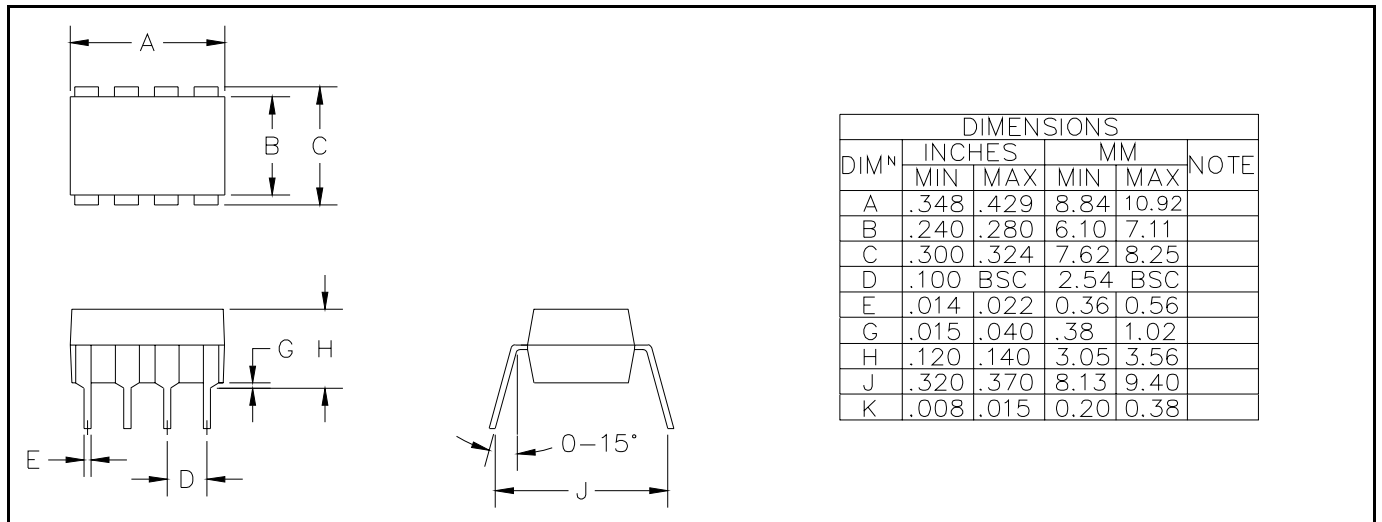

**Figure 4**

- Battery Splitter**  
 A common need in many systems is to obtain positive and negative supplies from a single battery or power supply system. Where current requirements are small, the circuit shown in Figure 4 is a simple solution.

January 30, 1998

**TYPICAL PERFORMANCE CHARACTERISTICS**

January 30, 1998

**TYPICAL PERFORMANCE CHARACTERISTICS (cont.)**

**OUTLINE DRAWING - 8-PIN DIP**

**OUTLINE DRAWING - SO-8**
